

HI97105

Marine Master Waterproof Multiparameter Photometer

pH, Alkalinity, Calcium,
Nitrate Low Range, Nitrate High Range,
Nitrite Ultra Low Range,
Phosphate Ultra Low Range



INSTRUCTION MANUAL

**Dear
Customer,**

Thank you for choosing a Hanna Instruments® product.
Please read this instruction manual carefully before using this instrument.
This manual will provide you with the necessary information for correct use of this instrument, as well as a precise idea of its versatility.
If you need additional technical information, do not hesitate to e-mail us at tech@hannainst.com or view our worldwide contact list at www.hannainst.com.

All rights are reserved. Reproduction in whole or in part is prohibited without the written consent of the copyright owner, Hanna Instruments Inc., Woonsocket, Rhode Island, 02895, USA.

TABLE OF CONTENTS

1. Preliminary Examination	4
2. Safety Measures	5
3. Abbreviations	5
4. Specifications	6
5. Description	8
5.1. General Description & Intended Use	8
5.2. Functional Description	9
5.3. Precision & Accuracy	10
5.4. Principle of Operation	10
5.5. Optical System	11
6. General Operations	12
6.1. Meter Validation: CAL Check™	12
6.2. Chemical Formula & Unit Conversion	13
6.3. Logging Data & Log Recall	14
6.4. General Setup	15
6.5. Reagents & Accessories	17
6.6. Contextual Help	17
7. Photometer	18
7.1. Method Selection	18
7.2. Reading Location Selection	18
7.3. Collecting & Measuring Samples and Reagents	19
7.4. Cuvette Preparation	20
7.5. Measurement Recommendations	21
7.6. Battery Management	21
8. Method Procedure	22
8.1. Marine pH	22
8.2. Marine Alkalinity	24
8.3. Marine Calcium	26
8.4. Marine Nitrate LR	28
8.5. Marine Nitrate HR	31
8.6. Marine Nitrite ULR	33
8.7. Marine Phosphate ULR	35
9. Warning & Error Descriptions	37
10. Battery Replacement	39
11. Accessories	40
Certification	41
Recommendations for Users	41
Warranty	42

1. PRELIMINARY EXAMINATION

Remove the instrument and accessories from the packaging and examine it carefully. For further assistance, please contact your local Hanna Instruments® office or email us at tech@hannainst.com.

Each **HI97105C** * is delivered in a rugged carrying case and is supplied with:

- Sample cuvette (2 pcs.)
- Sample cuvette cap (2 pcs.)
- Marine pH reagent, 30 mL dropper (1 pc.)
- Marine Alkalinity reagent, 30 mL (1 pc.)
- Marine Calcium reagent A, 30 mL (1 pc.)
- Marine Calcium reagent B starter kit (reagent for 25 tests)
- Marine Nitrate High Range starter kit (reagent for 25 tests)
- Marine Nitrite Ultra Low Range starter kit (reagent for 25 tests)
- Marine Phosphate Ultra Low Range starter kit (reagent for 25 tests)
- 1 mL graduated syringe with tip (2 pcs.)
- Minipipette with tip (1 pc.)
- 3 mL Pasteur pipette (2 pcs.)
- 1.5V AA Alkaline batteries (3 pcs.)
- Cloth for wiping cuvettes
- Scissors
- Instrument quality certificate
- Instruction manual

Each **HI97105** is supplied with:

- Sample cuvette (2 pcs.)
- Sample cuvette cap (2 pcs.)
- 1.5V AA Alkaline batteries (3 pcs.)
- Instrument quality certificate
- Instruction manual

Note: Save all packing material until you are sure that the instrument works correctly. Any damaged or defective item must be returned in its original packing material with the supplied accessories.

* **HI97105UC**, instrument code in the USA

2. SAFETY MEASURES



- The chemicals contained in the reagent kits may be hazardous if improperly handled.
- Read the Safety Data Sheets (SDS) before performing tests available on sds.hannainst.com.
- Safety equipment
Wear suitable eye protection and clothing when required, and follow instructions carefully.
- Reagent spills
If a reagent spill occurs, wipe up immediately and rinse with plenty of water. If reagent contacts skin, rinse the affected area thoroughly with water. Avoid breathing released vapors.
- Waste disposal
For proper disposal of reagent kits and reacted samples, contact a licensed waste disposal provider.

3. ABBREVIATIONS

dKH	Degree of carbonate hardness
EPA	US Environmental Protection Agency
HDPE	High Density Polyethylene
HR	High Range
LED	Light Emitting Diode
LR	Low Range
mg/L	Milligrams per liter (ppm)
NIST	National Institute of Standards and Technology
ppb	Parts per billion
ppm	Parts per million
RODI	Reverse Osmosis Deionized water
ULR	Ultra Low Range
μg/L	Micrograms per liter (ppb)

4. SPECIFICATIONS

Marine pH

Range	6.3 to 8.6 pH
Resolution	0.1 pH
Accuracy	± 0.2 pH of reading at 25 °C
Method	Colorimetric Adaptation of the Phenol Red Method
LED	525 nm

Marine Alkalinity

Range	0.0 to 20.0 dKH 0 to 357 ppm (as CaCO ₃)
Resolution	0.1 dKH
Accuracy	± 0.3 dKH ± 5 % of reading at 25 °C ± 5 ppm ± 5 % of reading at 25 °C
Method	Colorimetric Method The reaction causes a distinctive range of colors from yellow to greenish blue to develop
LED	610 nm

Marine Calcium

Range	200 to 600 ppm
Resolution	1 ppm
Accuracy	± 6 % of reading at 25 °C
Method	Adaptation of the Zincon Method
LED	610 nm

Marine Nitrate LR

Range	0.00 to 5.00 ppm (as NO ₃ ⁻)
Resolution	0.01 ppm
Accuracy	± 0.25 ppm ± 2 % of reading at 25 °C
Method	Colorimetric Method The reaction between nitrate and the reagent causes a pink/violet tint in the sample.
LED	525 nm

Marine Nitrate HR

Range	0.0 to 75.0 ppm (as NO ₃ ⁻)
Resolution	0.1 ppm
Accuracy	± 2.0 ppm ± 5 % of reading at 25 °C
Method	Zinc Reduction Method The reaction between nitrate and the reagent causes a pink tint in the sample.
LED	525 nm

Marine Nitrite ULR

Range	0 to 200 ppb (as NO ₂ ⁻ -N)
Resolution	1 ppb
Accuracy	± 10 ppb ± 4 % of reading at 25 °C
Method	Adaptation of the EPA Diazotization Method 354.1 The reaction between nitrite and the reagent causes a pink tint in the sample.
LED	525 nm

Marine Phosphate ULR

Range	0.00 to 0.90 ppm
Resolution	0.01 ppm
Accuracy	± 0.02 ppm ± 5 % of reading at 25 °C
Method	Adaptation of Standard Methods for the Examination of Water and Wastewater, 20 th Edition, Ascorbic Acid Method The reaction between phosphate and the reagent causes a blue tint in the sample.
LED	610 nm

Measurement System

Light source	Light Emitting Diode (LED)	
	Wavelength	525 nm & 610 nm
Bandpass filter	Bandwidth	8 nm
	Wavelength accuracy	± 1.0 nm
Light detector	Silicon photocell	
Cuvette type	Round 24.6 mm diameter (22 mm inside diameter)	

Additional Specifications

Auto logging	200 readings
Display	128 x 64 pixel B/W LCD with backlight
Auto-off	After 15 minutes of inactivity (30 minutes before a READ measurement)
Battery type	1.5 V AA Alkaline (3 pcs.)
Battery life	> 800 measurements (without backlight)
Environment	0 to 50 °C (32 to 122 °F); 0 to 100 % RH, non-serviceable
Dimensions	142.5 x 102.5 x 50.5 mm (5.6 x 4.0 x 2.0")
Weight	380 g (13.4 oz.); with batteries
Casing	IP67 rating, floating

5. DESCRIPTION

5.1. GENERAL DESCRIPTION & INTENDED USE

The HI97105 is a waterproof multiparameter portable photometer that benefits from Hanna[®]'s years of experience as a manufacturer of analytical instruments. It has an advanced optical system that uses a Light Emitting Diode (LED) and a narrow band interference filter that allows for accurate and repeatable readings.

The optical system is sealed from outside dust, dirt, and water. The meter uses an exclusive positive-locking system to ensure that the cuvettes are placed into the holder in the same position every time.

With the CAL Check[™] functionality, users are able to validate the performance of the instrument at any time. Hanna Instruments[®] CAL Check cuvettes are made with NIST traceable standards.

The built-in tutorial mode guides users step-by-step through the measurement process. It includes all steps required for sample preparation, the required reagents and quantities.

The HI97105 is a compact and versatile Marine multiparameter photometer designed to accurately determine pH, Alkalinity, Calcium, Nitrate, Nitrite, and Phosphate levels in aquariums and marine biology applications.

Methods covered:

- Marine pH — Colorimetric Adaptation of the Phenol Red Method (6.3 to 8.6 pH range)
- Marine Alkalinity — Colorimetric Method (0.0 to 20.0 dKH range)
- Marine Calcium — Adaptation of the Zincon Method (200 to 600 ppm range)
- Marine Nitrate LR — Colorimetric Method (0.00 to 5.00 ppm range)
- Marine Nitrate HR — Zinc Reduction Method (0.0 to 75.0 ppm range)
- Marine Nitrite ULR — Adaptation of the EPA Diazotization Method 354.1 (0 to 200 ppb range)
- Marine Phosphate ULR — Adaptation of Standard Methods for the Examination of Water and Wastewater, 20th Edition, Ascorbic Acid Method (0.00 to 0.90 ppm range)

The HI97105 photometer is suitable for field or bench measurements, featuring:

- Sophisticated optical system
- Meter validation using certified CAL Check cuvettes
- Tutorial mode guides the user step-by-step
- Option to assign locations to logged readings
- Auto logging
- Waterproof IP67, floating case



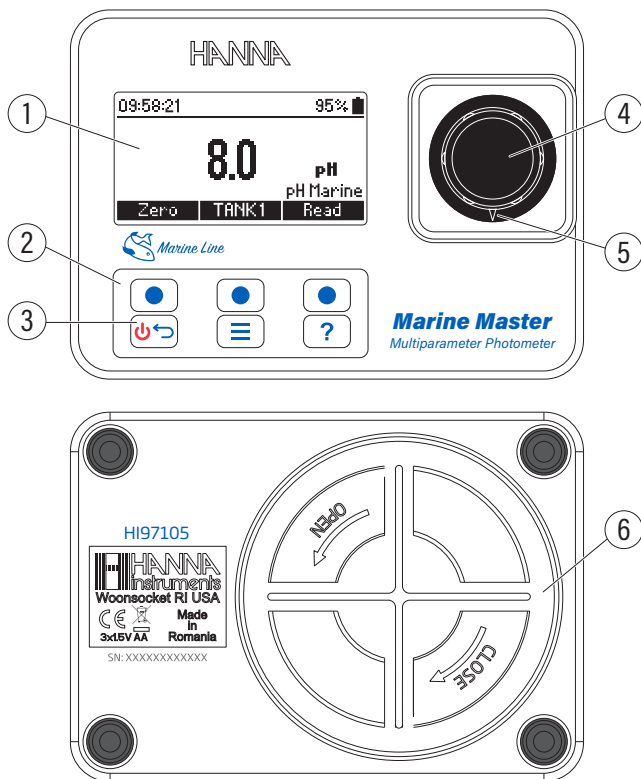

5.2. FUNCTIONAL DESCRIPTION



- | | |
|---------------------------------|-------------------|
| 1. Liquid Crystal Display (LCD) | 4. Cuvette holder |
| 2. Keypad | 5. Indexing mark |
| 3. ON/OFF power button | 6. Battery cover |

Keypad Description

The keypad contains 3 direct keys and 3 functional keys with the following functions:

-  Press the functional key to perform the function displayed above it on the LCD.
-  Press and hold to power off/on. Press briefly to return to the previous screen.
-  Press to access the menu screen.
-  Press to display the context-sensitive help menu.

5.3. PRECISION & ACCURACY

Precision is how closely repeated measurements are to one another. Precision is usually expressed as standard deviation (SD).

Accuracy is defined as the closeness of a test result to the true value and is method specific.

Although good precision suggests good accuracy, precise results can be inaccurate. The figure explains these definitions.

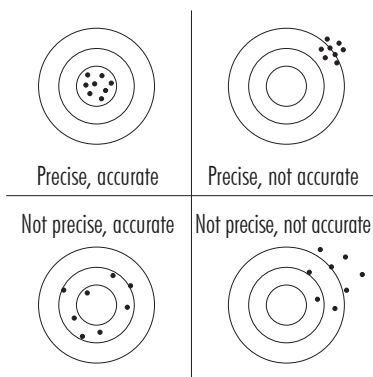

5.4. PRINCIPLE OF OPERATION

Absorption of light is a typical phenomenon of interaction between electromagnetic radiation and matter. When a light beam crosses a substance, some of the radiation may be absorbed by atoms, molecules, or crystal lattices. Photometric chemical analysis is based on specific chemical reactions between a sample and reagent to produce a light-absorbing compound.

If pure absorption occurs, the fraction of light absorbed depends both on the optical path length through the matter and on the physical-chemical characteristics of the substance according to the Lambert-Beer law. If all other factors are constant, the concentration "c" can be calculated from the absorbance of the substance.

Lambert-Beer law:

$$-\log I/I_0 = \epsilon_{\lambda} c d$$

or

$$A = \epsilon_{\lambda} c d$$

- I_0 = intensity of incident light beam
- I = intensity of light beam after absorption
- ϵ_{λ} = molar extinction coefficient at wavelength λ
- c = molar concentration of the substance
- d = optical path through the substance

5.5. OPTICAL SYSTEM

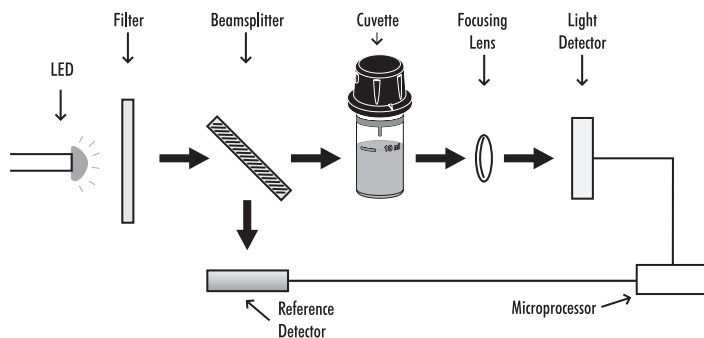

Instrument Block Diagram

The internal reference system (reference detector) of the [HI97105](#) photometer compensates for any drifts due to power fluctuations or ambient temperature changes, providing a stable source of light for the blank (zero) measurement and sample measurement.

LED light sources offer superior performance compared to tungsten lamps. LEDs have a much higher luminous efficiency, providing more light while using less power. They also produce little heat, which could otherwise affect electronic stability. LEDs are available in a wide array of wavelengths, whereas tungsten lamps have poor blue/violet light output.

Improved optical filters ensure greater wavelength accuracy and allow a brighter, stronger signal to be received. The end result is higher measurement stability and less wavelength error.

A focusing lens collects all of the light that exits the cuvette, eliminating errors from cuvette imperfections and scratches, eliminating the need to index the cuvette.

6. GENERAL OPERATIONS

6.1. METER VALIDATION: CAL CHECK™

Validation of the [HI97105](#) involves verifying the concentration of the certified CAL Check standards*. CAL Check screen guides the user step-by-step through the validation process.

WARNING: Do not use any solutions or standards other than the Hanna Instruments® CAL Check standards. For accurate validation, please perform it at room temperature, 18 to 25 °C (64.5 to 77.0 °F).

Note: Protect the CAL Check cuvettes from direct sunlight by keeping them in the original packing. Store between 5 and 30 °C (41 to 86 °F), do not freeze.

To perform a CAL Check:

1. Press the  key to enter menu. Use the functional keys to select *CAL Check* and press **Select**.

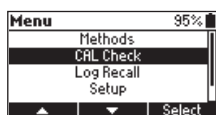
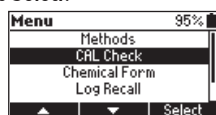

The “Not Available” message or the date, time, and status of the last CAL Check will be displayed on the screen.

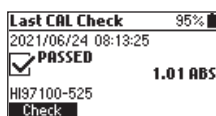
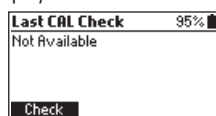

Note: CAL Check is for the bandpass filter used by the selected method. Methods with the same bandpass filter use the same CAL Check.

2. Press **Check** to start a new CAL Check. Press the  key at any time to abort the validation process.
3. Use the functional keys to enter the certificate value of the calibration standard found on the CAL Check Standard Certificate. Press **Next** to continue.



Note: This value will be saved in the instrument for future validation.

4. Insert the [HI97100-ZERO](#) CAL Check Cuvette A then press **Next** to continue. The “Please wait...” message will be displayed during the measurement.

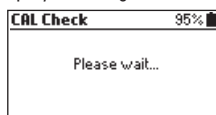

* CAL Check standards and testing reagents sold separately. Please refer to the Accessories section for ordering code.

5. Insert the CAL Check™ Cuvette B for the selected method (HI97100-525 for pH, Nitrate LR, Nitrate HR, Nitrite ULR or HI97100-610 for Alkalinity, Calcium, Phosphate ULR), then press **Next** to continue. The “Please wait...” message will be displayed during the measurement.

Note: HI97100-ZERO, HI97100-525, and HI97100-610 are included in the HI97105-11, CAL Check standards for HI97105 - cuvette kit.



6. When the CAL Check is complete, the display will show one of the following messages and the value obtained during the measurement:
 - “PASSED”: The measured value is within the accuracy specification.

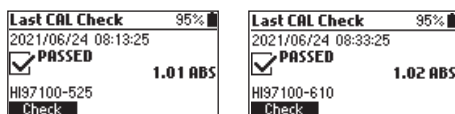

- “OUT OF SPECIFICATION”: The measured value is outside of the tolerance window. Check the certified value, expiration date and clean the outside of the cuvette. Repeat the CAL Check procedure. If this error continues, contact your nearest Hanna Instruments® Customer Service Center.

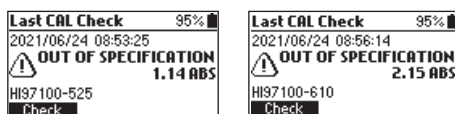

6.2. CHEMICAL FORMULA & UNIT CONVERSION

Chemical formula and unit conversion factors are method-dependent and are pre-programmed into the instrument. To view the displayed result in the desired chemical formula:

1. Press the  key to enter the menu.
2. Use the functional keys to select *Chemical Form* (if available for selected method)
3. Press **Select** to change the displayed chemical formula.
4. Use the functional keys to highlight desired chemical formula and press **Select**.

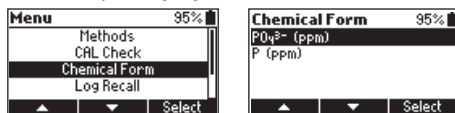

Note: At power on the instrument starts with the previously selected chemical form.

6.3. LOGGING DATA & LOG RECALL

The instrument features a data autolog function to help users keep track of all measurements. Every time a measurement is made the data is automatically saved. The data log can hold 200 individual measurements.

Note: When the data log is full (200 data points), the meter will rewrite the oldest data point. A confirmation message will display before a log is overwritten.

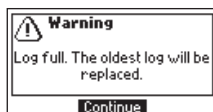

Viewing and deleting the data is possible using the *Log Recall* menu.

1. Press the  key to enter the menu. Use the functional keys to select *Log Recall* and press **Select**.

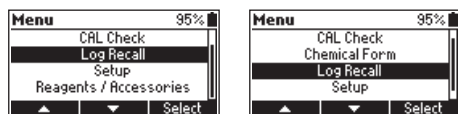

2. Use the functional keys to highlight a log and press **Info** to view additional information about the log. From this screen **Next** and **Previous** can be used to view other logs.

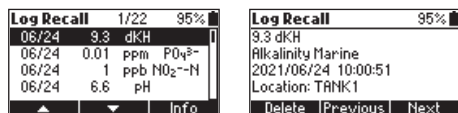

3. Press **Delete** to erase logged data. After pressing **Delete** a prompt on display is asking for confirmation.

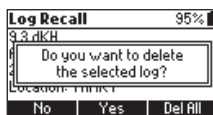

Press **No** or the  key to return to the previous screen.

Press **Yes** to delete selected log.

Press **Del All** to erase all the logged data. If **Del All** is pressed, follow the prompt to confirm. Press **Yes** to delete all logged data, **No**, or the  key to return to the log recall.



6.4. GENERAL SETUP

Press the  key to enter the menu. Use the functional keys to select *Setup* and press **Select**. Use the functional keys to highlight desired option.

Backlight

Option: 0 to 100 %

Press **Modify** to access the backlight intensity. Use the functional keys to increase or decrease the value. Press **Accept** to confirm or the  key to return to the *Setup* menu without saving the new value.

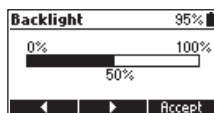
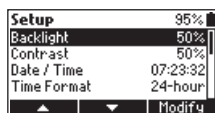

Contrast

Option: 0 to 100 %

Press **Modify** to change the display's contrast. Use the functional keys to increase or decrease the value. Press **Accept** to confirm the value or the  key to return to the *Setup* menu without saving the new value.

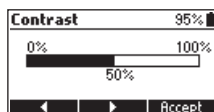
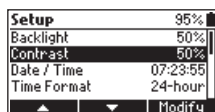

Date & Time

Press **Modify** to change the date and time. Press the functional keys to highlight the value to be modified (year, month, day, hour, minute, or second). Press **Edit** to modify the highlighted value. Use the functional keys to change the value.

Press **Accept** to confirm or the  key to return to the previous screen.

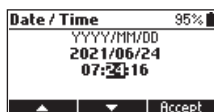
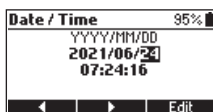
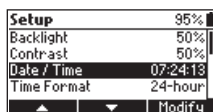

Time Format

Option: AM/PM or 24-hour

Press the functional key to select the desired time format.

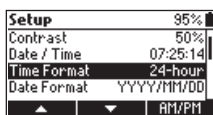

Date Format

Press **Modify** to change the date format. Use the functional keys to select the desired format. Press **Accept** to confirm or the  key to return to the *Setup* menu without saving the new format.

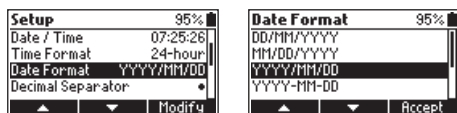

Decimal Separator

Option: Comma (,) or Period (.)

Press the functional key to select the desired decimal separator. The decimal separator is used on the measurement screen.

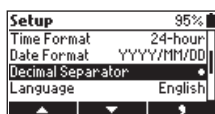

Language

Press **Modify** to change the language. Use the functional keys to select the desired language. Press **Accept** to choose one of the languages installed.

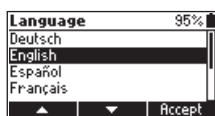
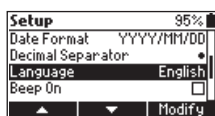

Beeper

Option: Enable or Disable

When enabled, a short beep is heard every time a key is pressed. A long beep alert sounds when the pressed key is not active or an error is detected. Press the functional key to enable or disable the beeper.

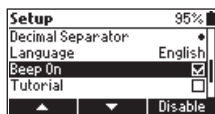

Tutorial

Option: Enable or Disable

Press the functional key to enable or disable the tutorial.

When enabled, the user will be guided step-by-step through the measurement procedure.

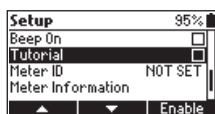

Meter ID

Press **Modify** and use the functional keys to set desired ID.

Press **Accept** to confirm or the  key to return to the *Setup* menu without saving the new Meter ID.

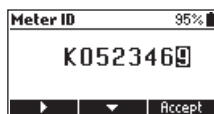
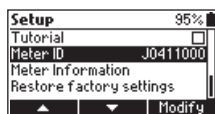

Meter Information

Press **Select** to view the model, serial number, firmware version and selected language.

Press the  key to return to the *Setup* menu.

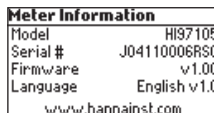
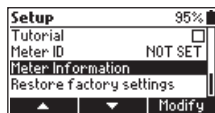

Restore Factory Settings

Press **Select** to reset to factory settings. Press **Accept** to confirm or **Cancel** to exit without restoring the factory settings.

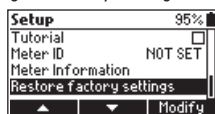

6.5. REAGENTS & ACCESSORIES

Press the  key to enter the menu.

Use the functional keys to select *Reagents / Accessories* and press **Select** to access a list of reagents and accessories. To exit press the  key.



6.6. CONTEXTUAL HELP

The HI97105 offers an interactive contextual help mode that assists the user at any time. To access the help screen, press the  key. The instrument will display additional information related to the current screen.

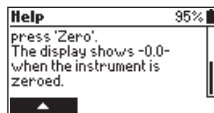
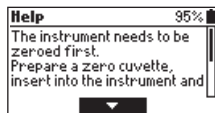



To read all the available information, scroll the text using the functional keys.

To exit help mode, press the  or the  key to return to the previous screen.

7. PHOTOMETER

7.1. METHOD SELECTION

1. Press the  key to enter the menu.
2. Use the functional keys to select *Methods* and press **Select**.
3. Use the functional keys to highlight the desired method then press **Select**.
4. Press the  or  key to return to measurement screen.

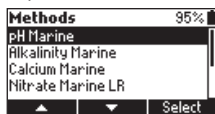

- If tutorial mode is disabled, follow the measurement procedure.
- If tutorial mode is enabled, press **Measure** and follow the messages on the screen.

Note: At power on the instrument starts with the previously selected method.

7.2. READING LOCATION SELECTION

The user has the option to select measurement location from a pre-defined list of ten different TANKS.

From menu, having previously selected required Method:

- Press  key to enter measurement screen.
- Press the corresponding functional key to select a location.

Notes: Changing measurement location resets the Zero reading.

At power on the instrument starts with the previously selected location.

Editing tank name

1. From measurement screen press the corresponding functional key.

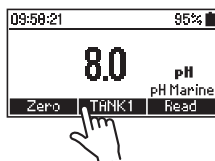

2. With option highlighted press **Rename**.
3. Use the functional keys to enter the name.

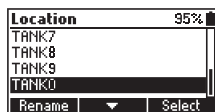

4. Press **Accept** to confirm.
5. Press the  key to (re) enter measurement screen.

7.3. COLLECTING & MEASURING SAMPLES AND REAGENTS

Proper Use of Powder Packet

1. Use scissors to open the powder packet.
2. Push the edges of the packet to form a spout.
3. Pour out the content of the packet.

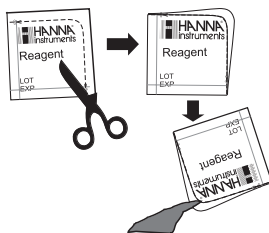

Proper Use of Dropper Bottle

1. Tap the dropper on the table several times. Wipe the outside of the tip with a cloth.
2. Always keep the dropper bottle in a vertical position while dosing the reagent.

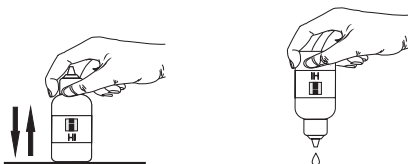

Proper Use of Syringe

1. Push the plunger completely into the syringe and insert the tip into the solution.
2. Pull the plunger up until the lower edge of the seal is exactly on the mark for the desired volume.
3. Take out the syringe and clean the outside of the syringe tip, be sure that no drops are hanging on the tip of the syringe. Then, keeping the syringe in vertical position above the cuvette, push the plunger down into the syringe, the desired volume has been delivered into the cuvette.

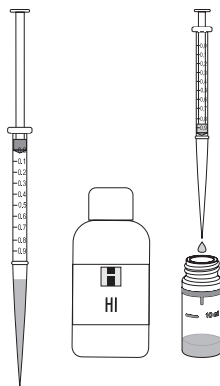

Proper Use of Minipipette

1. Attach the pipette tip.
2. Press the button down to the first stop.
3. Immerse the pipette tip in the liquid approximately 2-3 mm.
4. Slowly let the button move back to the original position, wait 2 seconds.
5. Remove the pipette tip from the liquid.
6. To dispense the liquid, place the pipette tip on the inside wall of the container.
7. Slowly press the button down to the first stop.
8. Wait until all of the liquid has been dispensed.
9. Press the button down to the second stop, this will allow any remaining liquid to be dispensed.

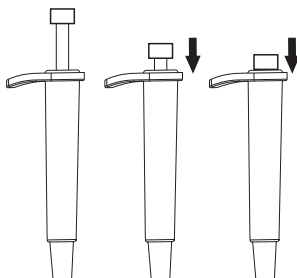

7.4. CUVETTE PREPARATION

Proper mixing is very important for reproducibility of the measurements. The proper mixing technique for each method is listed in the method procedure.

- (a) Invert the cuvette a couple of times or for a specified time: hold the cuvette in the vertical position. Turn the cuvette upside-down and wait for all of the solution to flow to the cap end, then return the cuvette to the upright vertical position and wait for all of the solution to flow to the cuvette bottom.

This is one inversion. The correct speed for this mixing technique is 10-15 complete inversions in 30 seconds.

This mixing technique is indicated with “invert to mix” and the following icons:

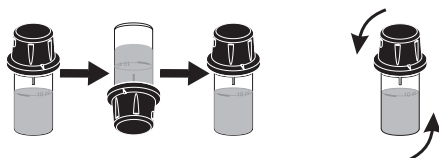

- (b) The mixing method is indicated with “shake gently” using one of the following icons:



- (c) The mixing method is indicated with “shake vigorously” using one of the following icons:

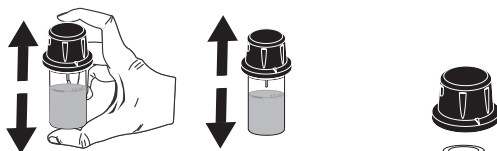

- In order to avoid reagent leaking and to obtain more accurate measurements, close the cuvette first with the supplied HDPE plastic stopper  and then the black cap.



7.5. MEASUREMENT RECOMMENDATIONS

- Whenever the cuvette is placed into the measurement holder, it must be dry outside and free of fingerprints, oil, or dirt. Wipe it thoroughly with HI731318 microfiber cleaning cloth or a lint-free wipe prior to insertion.
- Shaking the cuvette can generate bubbles in the sample, causing higher readings. To obtain accurate measurements, remove such bubbles by swirling or by gently tapping the cuvette.
- Do not let the reacted sample stand too long after reagent has been added. For best accuracy, respect the timings described in each method.
- It is possible to take multiple readings in a row, but it is recommended to take a new zero reading for each sample and to use the same cuvette for zeroing and measurement when possible.
- Discard the sample immediately after the reading has been taken, or the glass might become permanently stained.
- All the reaction times reported in this manual are at 25 °C (77 °F). In general, the reaction time should be increased for temperatures lower than 20 °C (68 °F), and decreased for temperatures higher than 25 °C (77 °F).

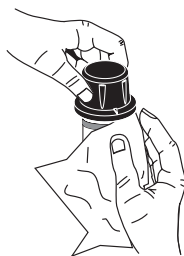

7.6. BATTERY MANAGEMENT

The meter will perform an auto-diagnostic test when it is powered on. During this test, the Hanna Instruments® logo will appear on the LCD. If the auto-diagnostic test was successful, the meter is ready for use. The battery icon on the LCD will indicate the battery status:

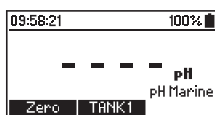

Battery is full

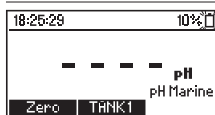

Battery is below 10 %.
Replace the batteries soon.

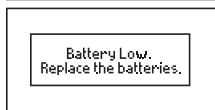

Battery is low.
Replace the batteries with new ones.

To conserve battery, the meter will turn off automatically after 15 minutes of inactivity. If a zero reading has been done but not a read, auto-off time is increased to 30 minutes.

8. METHOD PROCEDURE

8.1. MARINE pH

REQUIRED REAGENTS

Code	Description	Quantity
HI780-0	Marine pH Reagent	5 drops

REAGENT SETS

HI780-25	pH Reagent	100 tests
----------	------------	-----------

For other accessories see Accessories section.

MEASUREMENT PROCEDURE

Select the **pH Marine** method using the procedure described in Method Selection section.

Note: If tutorial mode is disabled, follow the measurement procedure below. If the tutorial mode is enabled, press **Measure** and follow the messages on the screen.

- Fill the cuvette with 10 mL of unreacted sample (up to the mark). Replace the plastic stopper and the cap.



- Insert the cuvette into the holder and ensure that the notch on the cap is positioned securely in the groove.

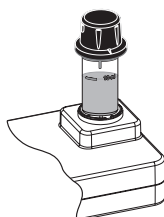

- Press **Zero**. The display will show “-0.0-” when the meter is zeroed and ready for measurement.

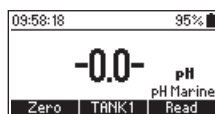
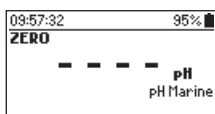
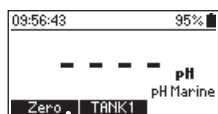

- Remove the cuvette.
- Add 5 drops of HI780-0 Marine pH Reagent indicator. Replace the plastic stopper and the cap. Invert 5 times to mix.

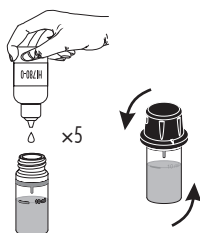

- Insert the cuvette into the holder and ensure that the notch on the cap is positioned securely in the groove.

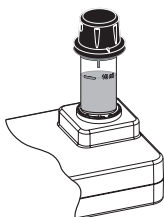

- Press **Read** to start reading.
The instrument displays the results in **pH**.

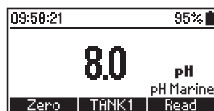
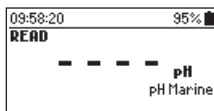

8.2. MARINE ALKALINITY

REQUIRED REAGENTS

Code	Description	Quantity
HI772S	Marine Alkalinity Reagent	1 mL

REAGENT SETS

HI772-26	Marine Alkalinity Reagent	25 tests
----------	---------------------------	----------

For other accessories see Accessories section.

MEASUREMENT PROCEDURE

Select the [Alkalinity Marine](#) method using the procedure described in Method Selection section.

Note: If tutorial mode is disabled, follow the measurement procedure below. If the tutorial mode is enabled, press **Measure** and follow the messages on the screen.

- Fill the cuvette with 10 mL of unreacted sample (up to the mark). Replace the plastic stopper and the cap.



- Insert the cuvette into the holder and ensure that the notch on the cap is positioned securely in the groove.

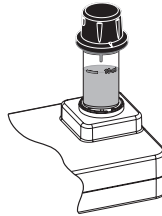

- Press **Zero**. The display will show “-0.0-” when the meter is zeroed and ready for measurement.

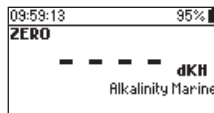
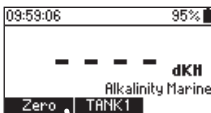

- Remove the cuvette.

- Use a 1 mL syringe and add 1 mL of HI772S Marine Alkalinity Reagent to the sample.

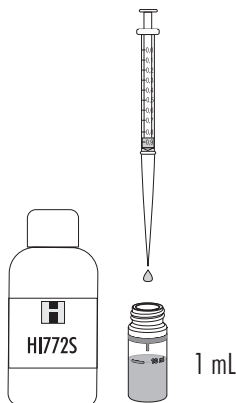

- Replace the plastic stopper and the cap. Invert 5 times to mix.

Note: Pay attention not to spill reagent otherwise full color development may be inhibited.

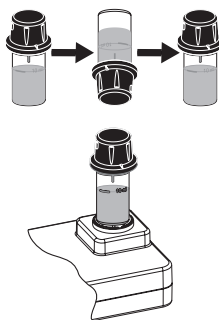

- Insert the cuvette into the holder and ensure that the notch on the cap is positioned securely in the groove.

- Press **Read** to start reading.

The instrument displays the results in degree KH (dKH).

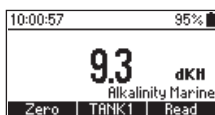
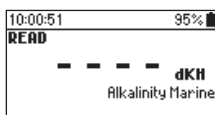

8.3. MARINE CALCIUM

REQUIRED REAGENTS

Code	Description	Quantity
HI7581	Marine Calcium Reagent A	1 mL
HI7582	Marine Calcium Reagent B	1 packet

REAGENT SETS

HI758-26	Marine Calcium Reagents	25 tests
----------	-------------------------	----------

For other accessories see Accessories section.

MEASUREMENT PROCEDURE

Select the [Calcium Marine](#) method using the procedure described in Method Selection section.

Note: If tutorial mode is disabled, follow the measurement procedure below. If the tutorial mode is enabled, press **Measure** and follow the messages on the screen.

- Use a 1 mL syringe and add 1 mL of HI7581 Marine Calcium Reagent A to the sample.

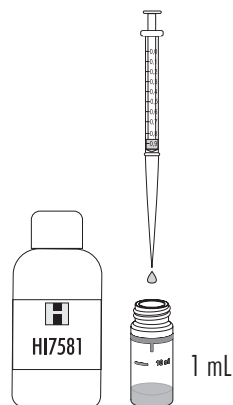

- Use the plastic pipette to fill the cuvette to the 10 mL mark with deionized water. Use Type 2 grade water or water that has electrical conductivity $\leq 1 \mu\text{S}/\text{cm}$. For best results, measure the deionized water with a clean, rinsed 10 mL syringe. Replace the plastic stopper and the cap. Invert 3 to 5 times to mix.

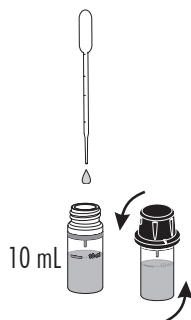

- Insert the cuvette into the holder and ensure that the notch on the cap is positioned securely in the groove.

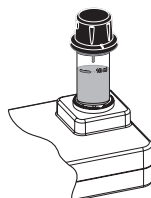

- Press **Zero**. The display will show “-0.0-” when the meter is zeroed and ready for measurement.

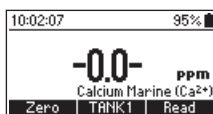
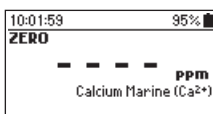
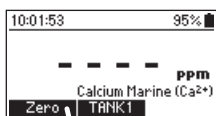

- Remove the cuvette.
- Use the minipipette to add 0.1 mL of sample to the cuvette. See Collecting & Measuring Samples and Reagents for tips for proper usage of the minipipette. Ensure no sample remains inside the tip after dispensing.



0.1 mL

- Add the content of one packet of **HI7582** Marine Calcium Reagent B. Replace the plastic stopper and the cap and shake vigorously for 15 seconds or until the powder is completely dissolved. Allow air bubbles to dissipate for 15 seconds before taking a reading.



- Insert the cuvette into the holder and ensure that the notch on the cap is positioned securely in the groove.

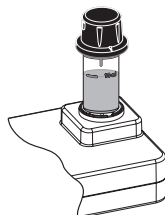

- Press **Read** to start reading.

The instrument displays the results in ppm of calcium (Ca²⁺).

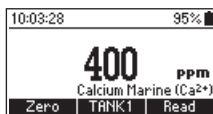
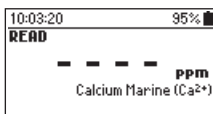
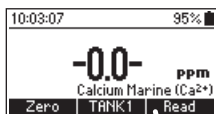

Note: Do not rinse cuvettes with tap water or tank water as these contain significant amounts of calcium. Always use deionized water.

8.4. MARINE NITRATE LR

REQUIRED REAGENTS

Code	Description	Quantity
HI781A-0	Marine Nitrate LR Reagent	4 mL
HI781B-0	Marine Nitrate LR Reagent	1 packet
HI781C-0	Marine Nitrate LR Reagent	1 packet

REAGENT SETS

HI781-25	Marine Nitrate LR Reagent	25 tests
--------------------------	---------------------------	----------

For other accessories see Accessories section.

PREPARE THE FILTER HOLDER ASSEMBLY

1. Unscrew the two halves of the reusable filter holder and carefully place one paper filter on the lower piece. The upper piece is marked 'TOP'; the lower piece has no marking.
Ensure the filter paper is on top of the clear colorless gasket in the filter holder.
2. Thread the upper piece over the lower piece and tighten securely. Ensure that the paper filter is not overlapping the threads.

The filter holder assembly is now ready for use.

Cleaning

To clean zinc powder residue from the filter holder assembly:

1. Unscrew the filter holder and gently pop the small ridged disk out of the upper half.
If necessary, use a small bristle brush and detergent.
2. Rinse thoroughly with Reverse Osmosis Deionized water (RODI) or tap water.
3. Dry before use.

FILTRATION & DILUTION

Filtering

To prevent the filter from tearing:

- Ensure that the filter and filter holder are dry before use.
- During filtering, keep a constant light pressure on the syringe plunger; it should take about 30 seconds for full filtration.
- Do not use excessive force.

Dilution

1. Measure 1 mL of sample using [HI740143](#) 1 mL graduated syringe.
2. Dispense into mixing vial.
3. Add nitrate/nitrite-free artificial seawater up to the 10 mL mark using [HI740157P](#) droppers.
4. Cap the vial and mix.

- Attach the blunt needle to the 10 mL syringe. To attach, screw the covered blunt needle and remove the cap to expose opening.
- Draw 7 mL of diluted sample into syringe and discard remaining 3 mL of sample from the mixing vial.
- Dispense 7 mL of diluted sample back into the empty mixing vial.

Continue with the normal procedure by adding HI781A-0. Multiply results by 10.

Note: Measurement accuracy will be affected by dilution. Measure dilution volumes carefully!

MEASUREMENT PROCEDURE

Select the **Nitrate Marine LR** method using the procedure described in Method Selection.

Note: If tutorial mode is disabled, follow the measurement procedure below. If the tutorial mode is enabled, press **Measure** and follow the messages on the screen.

Note: For samples containing 5-50 ppm nitrate, follow the dilution procedure.

- Use a 10 mL syringe and measure exactly 7 mL of sample into a mixing cuvette (# 1).
- Use a 5 mL syringe and add exactly 4 mL of HI781A-0 Marine Nitrate LR Reagent into the mixing cuvette.

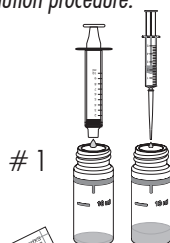

- Add the content of one packet of HI781B-0 Marine Nitrate LR Reagent into the mixing cuvette. Replace the plastic stopper and cap. Shake vigorously for 1 minute.

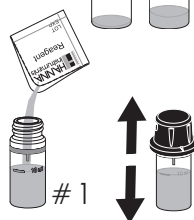

- Remove the cap of the mixing cuvette. Thread the covered needle onto the 10 mL syringe, remove the plastic cover and draw up the contents of the mixing cuvette into the syringe.

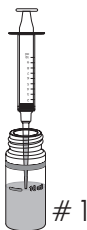

- Cover the needle with plastic cover and twist to remove. Add the filter to filter holder assembly and attach to the 10 mL syringe using the threaded connection. Hold the syringe and filter holder assembly over a cuvette (# 2).
- Very slowly push the plunger into the 10 mL syringe until the 10 mL cuvette has been filled up to the 10 mL mark. Replace the plastic stopper and the cap.



- Insert the cuvette into the holder and ensure that the notch on the cap is positioned securely in the groove.

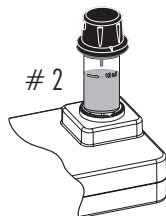

- Press **Zero**. The display will show “-0.0-” when the meter is zeroed and ready for measurement.

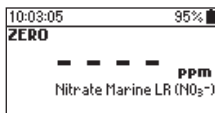

- Remove the cuvette.
- Add the content of one packet of **HI781C-0** Marine Nitrate LR Reagent. Replace the plastic stopper and the cap. Shake vigorously for 2 minutes.

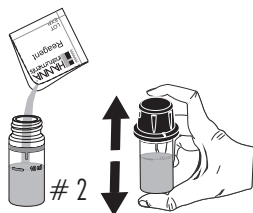

- Insert the cuvette into the holder and ensure that the notch on the cap is positioned securely in the groove.

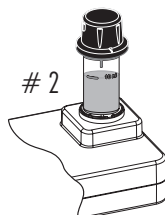

- Press **Read**. The display will show an 8 minute countdown prior to the measurement. To skip the timer, press **Read**. When the timer ends the meter will perform the reading. The instrument displays the results in **ppm** of nitrate (NO_3^-).

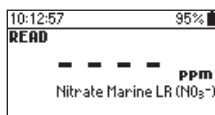

INTERFERENCES

Interference may be caused by:

- Nitrite, Copper

8.5. MARINE NITRATE HR

REQUIRED REAGENTS

Code	Description	Quantity
HI782-0	Marine Nitrate HR Reagent	1 packet

REAGENT SETS

HI782-25	Marine Nitrate HR Reagent	25 tests
----------	---------------------------	----------

For other accessories see Accessories section.

MEASUREMENT PROCEDURE

Select the **Nitrate Marine HR** method using the procedure described in Method Selection section.

Note: If tutorial mode is disabled, follow the measurement procedure below. If the tutorial mode is enabled, press **Measure** and follow the messages on the screen.

- Fill the cuvette with 10 mL of unreacted sample (up to the mark). Replace the plastic stopper and the cap.



- Insert the cuvette into the holder and ensure that the notch on the cap is positioned securely in the groove.

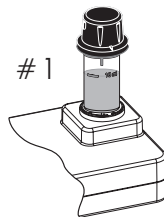

- Press **Zero**. The display will show “-0.0-” when the meter is zeroed and ready for measurement.

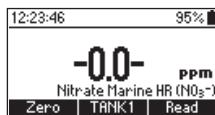
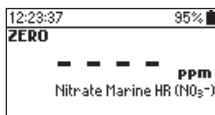
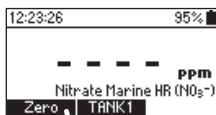

- Remove the cuvette.
- Add the content of one packet of **HI782-0** Marine Nitrate HR Reagent. Replace the plastic stopper and the cap. Shake vigorously for 2 minutes.

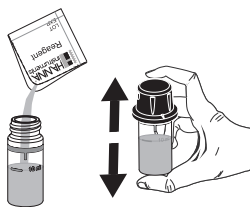

- Insert the cuvette into the holder and ensure that the notch on the cap is positioned securely in the groove.

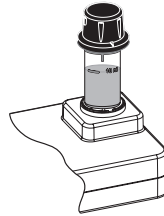

- Press **Read**. The display will show a 7 minute countdown prior to the measurement. To skip the timer, press **Read**. When the timer ends, the meter will perform the reading. The instrument displays the results in **ppm** of nitrate (NO_3^-).

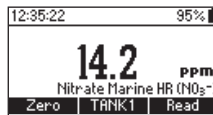
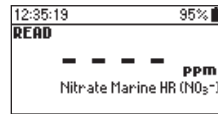

INTERFERENCES

Interference may be caused by:

- Nitrite

8.6. MARINE NITRITE ULR

REQUIRED REAGENTS

Code	Description	Quantity
HI764-0	Marine Nitrite ULR Reagent	1 packet

REAGENT SETS

HI764-25	Marine Nitrite ULR	25 tests
----------	--------------------	----------

For other accessories see Accessories section.

MEASUREMENT PROCEDURE

Select the [Nitrite Marine ULR](#) method using the procedure described in Method Selection section.

Note: If tutorial mode is disabled, follow the measurement procedure below. If the tutorial mode is enabled, press **Measure** and follow the messages on the screen.

- Fill the cuvette with 10 mL of unreacted sample (up to the mark). Replace the plastic stopper and the cap.



- Insert the cuvette into the holder and ensure that the notch on the cap is positioned securely in the groove.

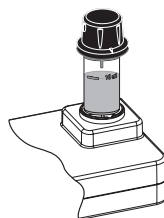

- Press **Zero**. The display will show “-0.0-” when the meter is zeroed and ready for measurement.

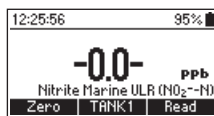
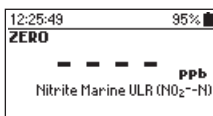
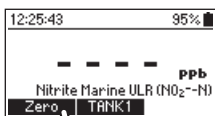

- Remove the cuvette.
- Add the content of 1 packet of [HI764-0](#) Marine Nitrite ULR Reagent. Replace the plastic stopper and the cap. Shake gently for about 15 seconds.

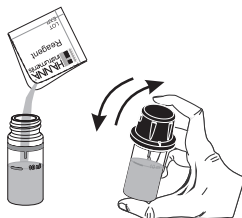

- Insert the cuvette into the holder and ensure that the notch on the cap is positioned securely in the groove.

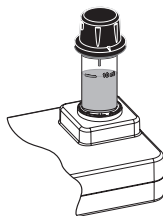

- Press **Read**. The display will show a 15 minute countdown prior to the measurement. To skip the timer, press **Read**. When the timer ends, the meter will perform the reading. The instrument displays the results in $\mu\text{g/L}$ of nitrite-nitrogen ($\text{NO}_2^- - \text{N}$).

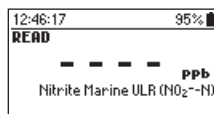

INTERFERENCES

Interference may be caused by:

- Antimonious, Auric, Bismuth, Chloroplatinate ions, Cupric, Iron (Ferric), Iron (Ferrous), Lead, Mercurous, Silver, Strong reducing or oxidating agents
- Nitrate above 100 ppm could yield falsely high readings

8.7. MARINE PHOSPHATE ULR

REQUIRED REAGENTS

Code	Description	Quantity
HI774-0	Marine Phosphate ULR Reagent	1 packet

REAGENT SETS

HI774-25	Marine Phosphate ULR Reagent	25 tests
----------	------------------------------	----------

For other accessories see Accessories section.

MEASUREMENT PROCEDURE

Select the [Phosphate Marine ULR](#) method using the procedure described in Method Selection section.

Note: If tutorial mode is disabled, follow the measurement procedure below. If the tutorial mode is enabled, press **Measure** and follow the messages on the screen.

- Fill the cuvette with 10 mL of unreacted sample (up to the mark). Replace the plastic stopper and the cap.



- Insert the cuvette into the holder and ensure that the notch on the cap is positioned securely in the groove.

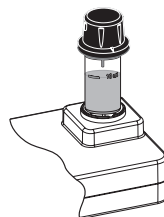

- Press **Zero**. The display will show “-0.0-” when the meter is zeroed and ready for measurement.

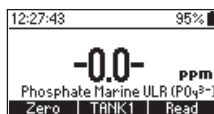
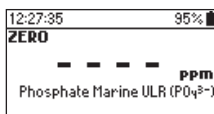
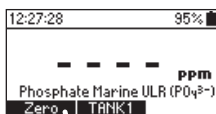

- Remove the cuvette.
- Add the content of one packet of [HI774-0](#) Marine Phosphate ULR Reagent. Replace the plastic stopper and the cap. Shake gently (for about 2 minutes) until the powder is completely dissolved.

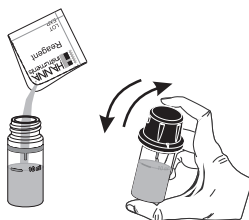

- Insert the cuvette into the holder and ensure that the notch on the cap is positioned securely in the groove.

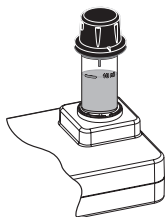

- Press **Read**. The display will show a 3 minute countdown prior to the measurement. To skip the timer, press **Read**. When the timer ends, the meter will perform the reading. The instrument displays the results in **ppm** of **phosphate (PO_4^{3-})**.

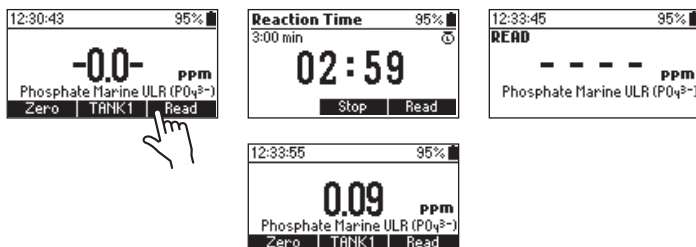

- Press the  key and use the functional keys to select *Chemical Form*.

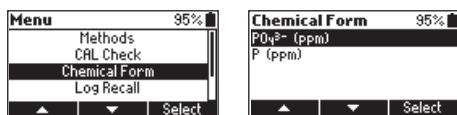

- Use the functional keys and press **Select** to change the displayed chemical formula to **ppm** of **phosphorus (P)**.

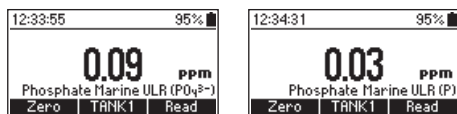

INTERFERENCES

Interference may be caused by:

- Iron, Silica above 50 ppm
- Copper, Silicate above 10 ppm
- Hydrogen sulfide, arsenate, turbid sample and highly buffered samples

9. WARNING & ERROR DESCRIPTIONS

The instrument shows clear warning messages when erroneous conditions appear and when measured values are outside the expected range.

The information below provides an explanation of the errors and warnings, and recommended action to be taken.

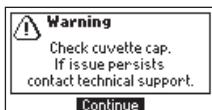

There is an excess amount of ambient light reaching the detector. Ensure that the notch on the cap is positioned securely in the groove before performing any measurements. If the issue persists, please contact Hanna Instruments® technical support.



The sample and the zero cuvettes are inverted. Swap the cuvettes and repeat the measurement.

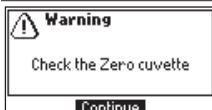

There is either too much light or the instrument can not adjust the light level. Please check the preparation of the zero cuvette and that the sample does not contain any debris.



The meter is either overheating or its temperature has dropped too low to operate within published accuracy specifications. The meter must be between 0 and 50 °C (32 and 122 °F) to perform any measurements.



Meter temperature has changed significantly since the zero measurement has been performed. The zero measurement must be performed again.

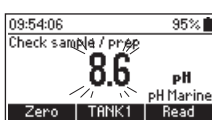

The measured value is outside the limits of the method. Verify that the sample does not contain any debris. Check the sample preparation, the measurement preparation and method range.



Date and time settings have been lost. Reset the values. If the issue persists, please contact Hanna Instruments technical support.

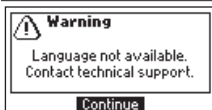

English is the only available language. Help function is not available. Restart the meter. If the issue persists, please contact Hanna Instruments technical support.

<p>Battery Low. Replace the batteries.</p>	<p>Battery level is too low for the meter to function properly. Replace the batteries with new ones.</p>
<p>Info Tutorial Mode is Enabled. Continue</p>	<p>Tutorial mode has been enabled in the Setup menu. Press Continue and follow the prompt on the screen. Tutorial mode can be disabled in the Setup menu.</p>
<p>Warning Log full. The oldest log will be replaced. Continue</p>	<p>The log is full (200 logs). New logs will replace the oldest. Displays before a new log would overwrite the oldest record. Press Continue to accept.</p>
<p>Error Restart the meter. If issue persists contact technical support. Continue</p>	<p>A critical error has occurred. Restart the meter. If the issue persists, please contact Hanna Instruments[®] technical support.</p>

10. BATTERY REPLACEMENT

To replace the instrument's batteries, follow these steps:

1. Turn the instrument off by pressing and holding the  key.
2. Remove the battery cover by turning it counterclockwise.
3. Remove the old batteries, replace them with three new 1.5V AA batteries.
4. Replace the battery cover, turn it clockwise to close.

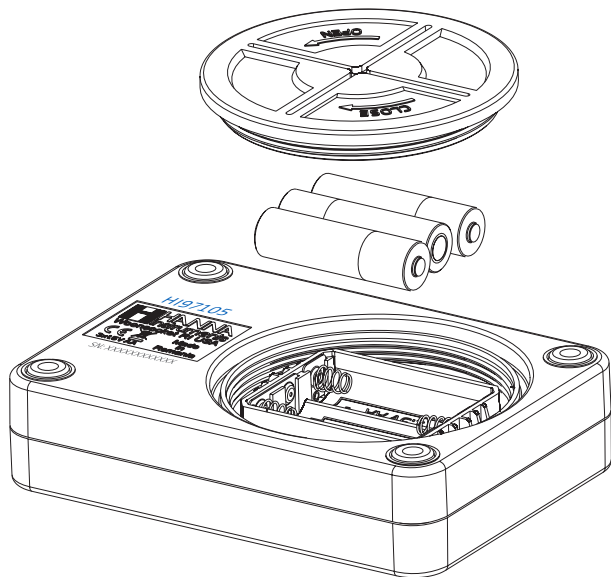

11. ACCESSORIES

Ordering Information	Product Description
Reagent Sets	
HI758-26	Marine Calcium Reagent - 25 tests
HI758U-26 *	Marine Calcium Reagent - 25 tests
HI764-25	Marine Nitrite ULR Reagent - 25 tests
HI772-26	Marine Alkalinity Reagent - 25 tests
HI774-25	Marine Phosphate ULR Reagent - 25 tests
HI780-25	Marine pH Reagent - approximately 100 tests
HI781-25	Marine Nitrate LR Reagent - 25 tests
HI782-25	Marine Nitrate HR Reagent - 25 tests
Reagent Standards	
HI97105-11	CAL Check™ standards for HI97105 - cuvette kit
Other Accessories	
HI70436M	Deionized water (230 mL)
HI7101418	Blue carrying case for HI97105C
HI731318	Cloth for wiping cuvettes (4 pcs.)
HI731331	Glass cuvette (4 pcs.)
HI731360	Glass cuvette with cap (2 pcs.)
HI731336N	Cap for glass cuvette (4 pcs.)
HI731339P	0.1 mL minipipette
HI731349P	Tip for 0.1 mL minipipette (10 pcs.)
HI740142P	1 mL graduated syringe (10 pcs.)
HI740143	1 mL graduated syringe (6 pcs.)
HI740144P	Plastic tip for 5 mL syringe (10 pcs.)
HI740157P	Plastic refilling pipette (20 pcs.)
HI740226	5 mL graduated syringe (1 pc.)
HI740228	Filter disc (25 pcs.)
HI740270	10 mL syringe with Luer Lock (1 pc.)
HI740271	Filter holder with Luer Lock (1 pc.)
HI740272	16 gauge blunt needle (6 pcs.)
HI740273	Marine Nitrate LR measurement kit (1 pc.)
HI93703-50	Cuvette cleaning solution (230 mL)

* Ordering code in the USA

CERTIFICATION

All Hanna[®] instruments conform to the CE European Directives.



Disposal of Electrical & Electronic Equipment. The product should not be treated as household waste. Instead, hand it over to the appropriate collection point for the recycling of electrical and electronic equipment, which will conserve natural resources.

Disposal of waste batteries. This product contains batteries, do not dispose of them with other household waste. Hand them over to the appropriate collection point for recycling. Ensuring proper product and battery disposal prevents potential negative consequences for the environment and human health. For more information, contact your city, your local household waste disposal service, or the place of purchase.



RECOMMENDATIONS FOR USERS

Before using this product, make sure it is entirely suitable for your specific application and for the environment in which it is used. Any variation introduced by the user to the supplied equipment may degrade the meter's performance. For your and the meter's safety do not use or store the meter in hazardous environments.

WARRANTY

The HI97105 is warranted for two years against defects in workmanship and materials when used for its intended purpose and maintained according to instructions. This warranty is limited to repair or replacement free of charge. Damage due to accidents, misuse, tampering, or lack of prescribed maintenance is not covered.

If service is required, contact your local Hanna Instruments® office. If under warranty, report the model number, date of purchase, serial number (engraved on the bottom of the meter), and the nature of the problem. If the repair is not covered by the warranty, you will be notified of the charges incurred. If the meter is to be returned to Hanna Instruments, first obtain a Returned Goods Authorization (RGA) number from the Technical Service department and then send it with shipping costs prepaid. When shipping any meter, make sure it is properly packed for complete protection.

Hanna Instruments[®] reserves the right to modify the design, construction, or appearance of its products without advance notice.

World Headquarters

Hanna Instruments Inc.
Highland Industrial Park
584 Park East Drive
Woonsocket, RI 02895 USA
www.hannainst.com



MAN97105

Printed in ROMANIA